

ALLEGRI

BY KALCO LIGHTING

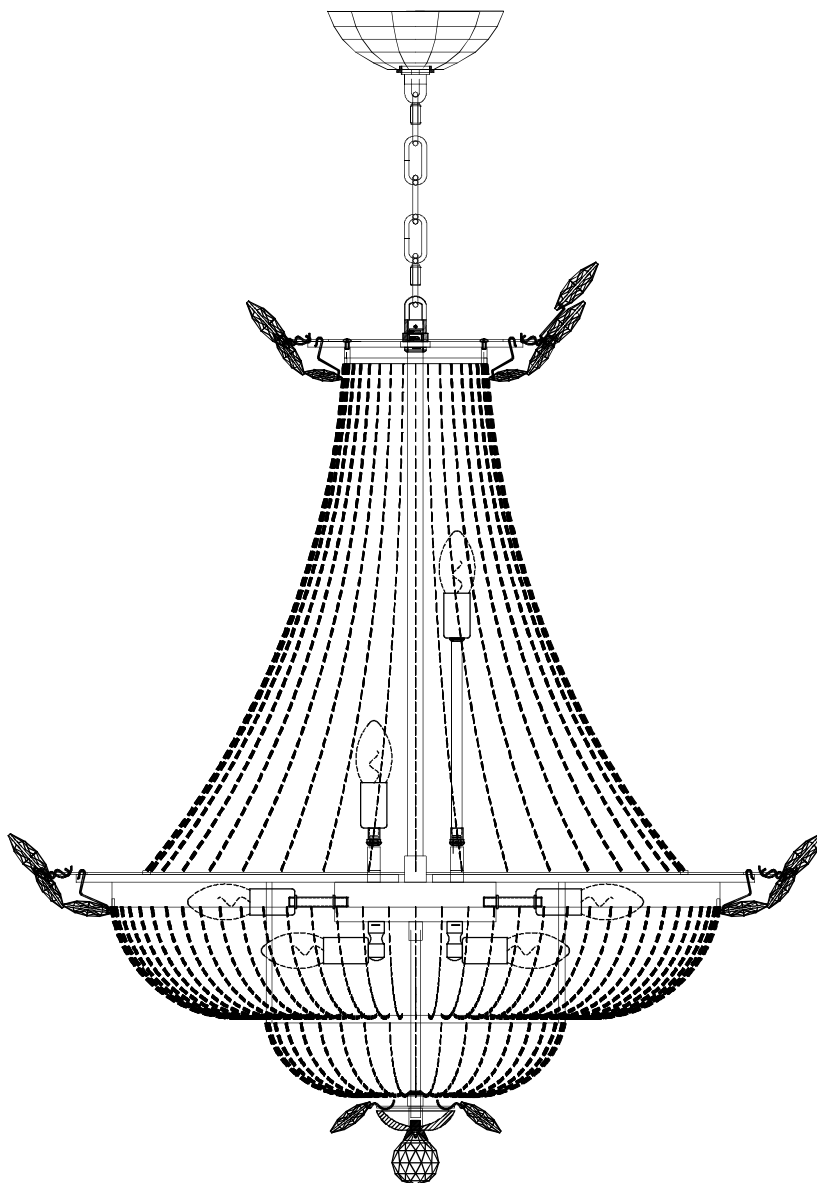

MODEL 020572

ASSEMBLY AND DRESSING INSTRUCTIONS

Blending innovative design, cutting-edge technology and the grace and elegance of traditional crystal, ALLEGRI® proudly brings you a new approach to lighting. ALLEGRI® fixtures are made from the finest raw materials and are brought to life through a combination of traditional manufacturing, such as sand casting, hand-forging and technology driven techniques including laser cutting.

Enclosed are detailed instructions on how to properly install your fixture. Please read all instructions carefully. If you need further assistance, please contact the dealer from which you purchased this product or call 866-820-2665 to speak with an ALLEGRI® customer service representative. We hope you enjoy your fixture!

ALLEGRI



BY KALCO LIGHTING

ASSEMBLY AND DRESSING INSTRUCTIONS

WARNING! **CONTENTS ARE FRAGILE** **HANDLE WITH CARE**

THE METAL FRAME, FINISH AND CRYSTAL COMPONENTS OF THIS CHANDELIER ARE VERY DELICATE.
PLEASE EXERCISE EXTREME CAUTION DURING UNPACKING AND INSTALLATION.

PLACE ALL PIECES TOGETHER IN A NUMERICAL ORDER AND IN THE ORIENTATION DEPICTED.
REFER TO THE PARTS LIST TO AVOID ANY CONFUSION BETWEEN PARTS THE PARTS NUMBER MUST COINCIDE.

CAUTION: FAILURE TO INSTALL THIS FIXTURE PROPERLY MAY RESULT IN SERIOUS PERSONAL INJURY AND PROPERTY DAMAGE. All electrical components must be installed only by a Licensed Electrician.

This product must be installed in accordance with the National Electric Code (NEC), and appropriate local electrical code(s), by a person familiar with the construction and operation of the product and the hazard involved.*

CAUTION: Do not exceed maximum wattage note on fixture. Uses only recommended bulbs with fixture.

GENERAL NOTES

- ❖ For your safety and proper operation of fixture, read and understand all instructions completely before commencing installation.
- ❖ This fixture is suited for dry locations. Never install fixture on damp ceiling; room should be dry and well ventilated.
- ❖ Extreme care should be taken to avoid damage to the surface of lighting fixture and wires. Wearing gloves is recommended for installation.
- ❖ Connect ribbed wire of lighting fixture to live wire, while smooth wire of lighting to neutral. Connect bare copper or silver color ground wire of fixture to the double colored or green wire of outlet box.
- ❖ Use UL LISTED wire nuts for the wiring connections in this fixture. Wrap wire nut connections with UL LISTED electrical tape.
- ❖ Keep lighting away from acid, alkali and other corrosive chemical or gas; clean the fixture with a clean cloth only.
- ❖ Fixture must be firmly secured when installing ceiling tube, chain pipe and other connecting parts.
- ❖ Never cover the lighting fixture when power is connected.
- ❖ Disconnect the power before installing, cleaning and/or replacing light bulb.
- ❖ Extreme care should be taken when installing and cleaning of Glass and/or Crystal Components.
- ❖ This product is rated 110-130V/60HZ bulb 40W Maximum.
- ❖ Save these instructions for future reference.

WARNING

The electricity must be turned off at the main fuse box or circuit breaker before installing this fixture. Turning the power off using the light switch may not be sufficient to prevent electrical shock.

*ALLEGRI will not be liable for injury or damage caused by improper installation, lamping or use of this fixture.

ALLEGRI

BY KALCO LIGHTING

CANOPY MOUNTING INSTRUCTION

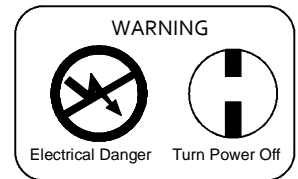

All electrical components must be installed by a licensed electrician in accordance with the National Electric code and the appropriate local electrical codes.

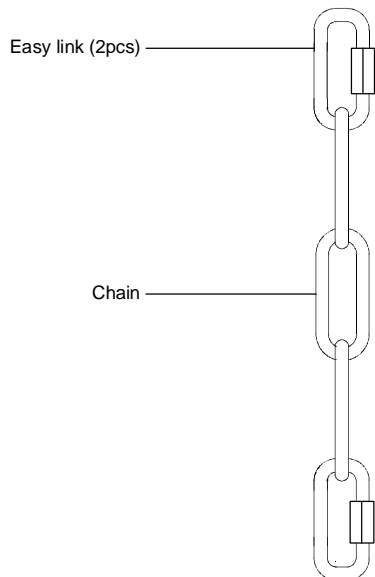
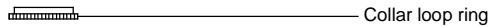
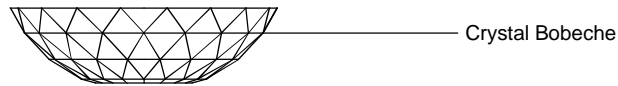
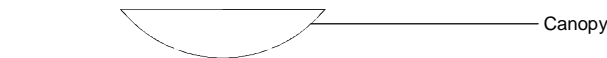
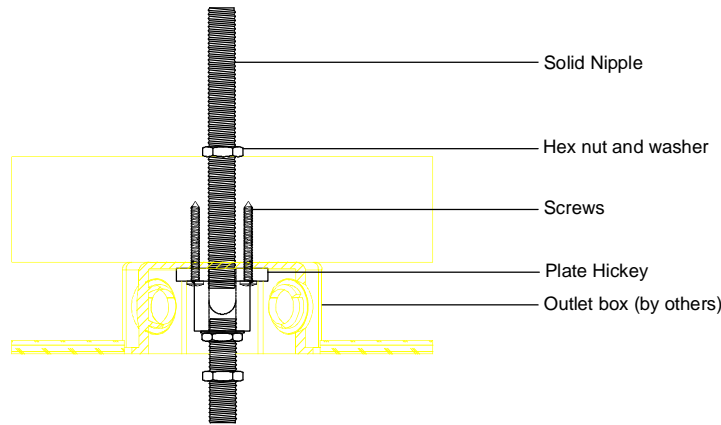

INSTALL CANOPY AS FOLLOWS

CAUTION: Be sure power is off at the main breaker box prior to installation.

1. Drill a hole on main ceiling beam and pass Solid Nipple through.
2. Place Washer and Hex Nut on top of Solid Nipple to hold.
3. Take Outlet Box through Solid Nipple and screw Plate Hickey, then screw Plate Hickey to main ceiling beam with 4 screws.
4. Secure the Washer and Hex Nut to Solid Nipple from top side of main ceiling beam.
5. Screw Collar Loop to Nipple as shown, raise Canopy flat to ceiling and secure it with Collar Loop Ring.
6. Hang Chain to Collar Loop with the Easy Link,
7. Measure chain and cut if needed with bolt cutter to desired length.

Proceed to fixture frame assembly on next page 4.

ALLEGRI

BY KALCO LIGHTING

FRAME ASSEMBLY INSTRUCTIONS

MODEL 020572

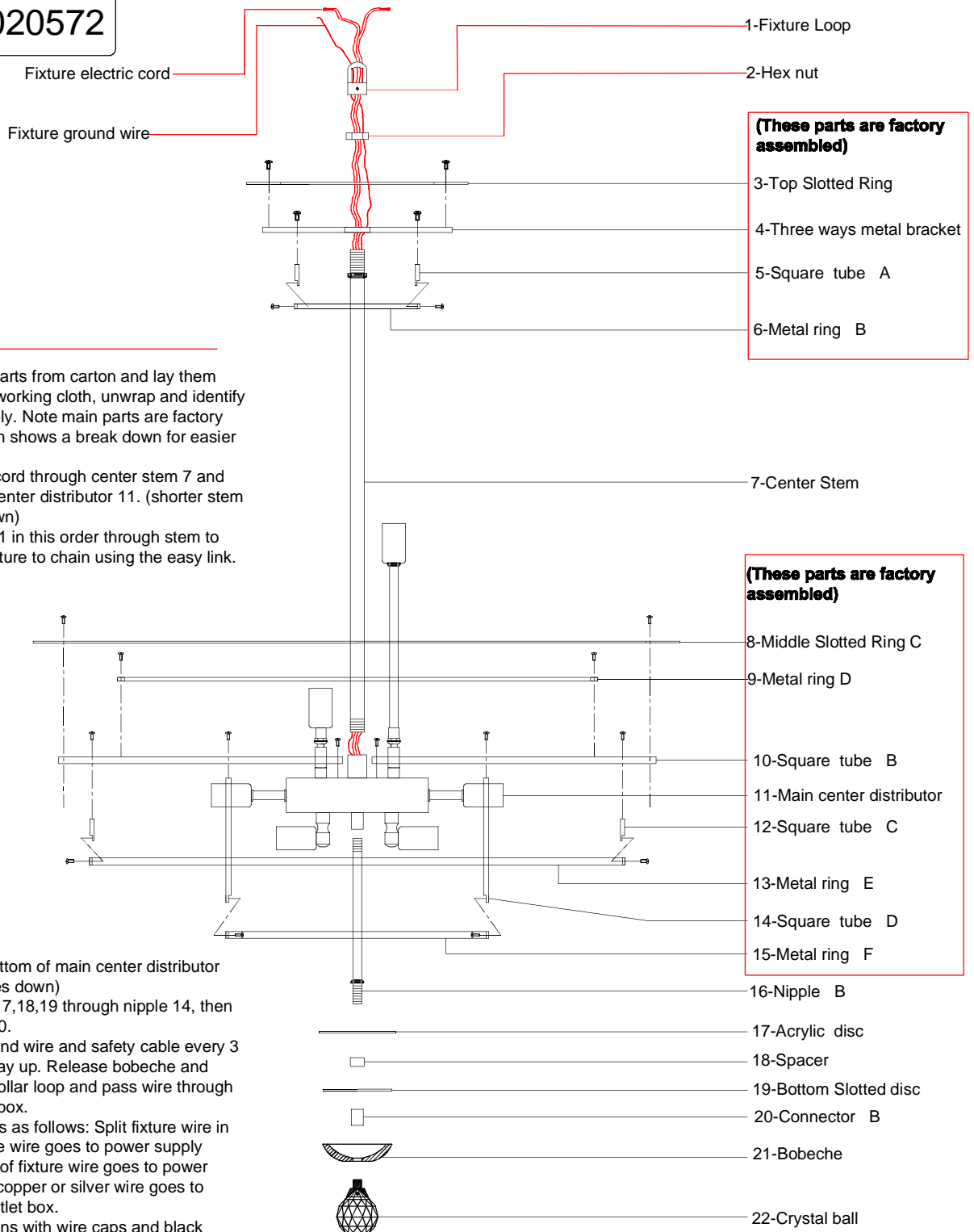

Frame Assembly:

A- Please take out all parts from carton and lay them down on a clean soft working cloth, unwrap and identify all parts before assembly. Note main parts are factory assembled and diagram shows a break down for easier ordering purposes.

B-Pass fixture electric cord through center stem 7 and screw stem into main center distributor 11. (shorter stem threaded side goes down)

C-Pass parts 6,5,4,3,2,1 in this order through stem to finish top part. Hang fixture to chain using the easy link.

D-Screw Nipple 14 to bottom of main center distributor (Longer threads end goes down)

E-Pass parts 14, 15,16,17,18,19 through nipple 14, then install crystal ball finial 20.

F-Lace fixture cord, ground wire and safety cable every 3 or 4 chain links all the way up. Release bobèche and canopy by unscrewing collar loop and pass wire through to reach inside of outlet box.

G-Make wire connections as follows: Split fixture wire in two, ribbed side of fixture wire goes to power supply black wire. Smooth side of fixture wire goes to power supply white wire. Bare copper or silver wire goes to green ground wire on outlet box.

H-Secure wire connections with wire caps and black electrical tape or as your local electric code. Tuck excess of wire carefully inside outlet box. Raise canopy and bobèche flat to ceiling and secure them by screwing collar loop.

Install all light bulbs. Candelabra 40w Krypton bulbs are recommended.

ALLEGRI

BY KALCO LIGHTING

CRYSTAL DRESSING INSTRUCTION

MODEL 020572-010-FR001

NOTE: Please unwrap all crystal parts and lay them down on a working clean soft cloth. Identify and organize all parts before assembly starts.

1-Attach 36 crystal strands (F) starting from top ring first, then attach the bottom end of strands to middle ring

2-Attach 72 crystal strands (H) starting from middle ring first, then attach the bottom of strand to ring 15.

3-Attach 36 crystal strands (K) starting from bottom of ring 15, then attach the bottom of strand to bottom acrylic disc 17.

4-Insert crystals (D) to top slotted ring as shown in (fig1 D) to the right, use (top slotted ring top view) diagram below as a reference.

5-Insert crystal C, A, E in this order to finish pattern for top ring.

6-Insert crystal (D) to Middle slotted ring as shown in (fig1 D) to the right, use (Middle slotted ring top view) diagram as a reference

7-Insert crystals B, A, G, in this order to finish pattern for middle ring.

8-Remove crystal (I) and bottom bobèche, release bottom slotted ring to allow space so you can insert 10 crystals (J) when finish, place bottom bobèche and crystal (I) back in place.

Candelabra base 40Watt Krypton Bulbs are recommended for your fixture.

Keep this instructions for future reference to order replacement parts for your fixture.

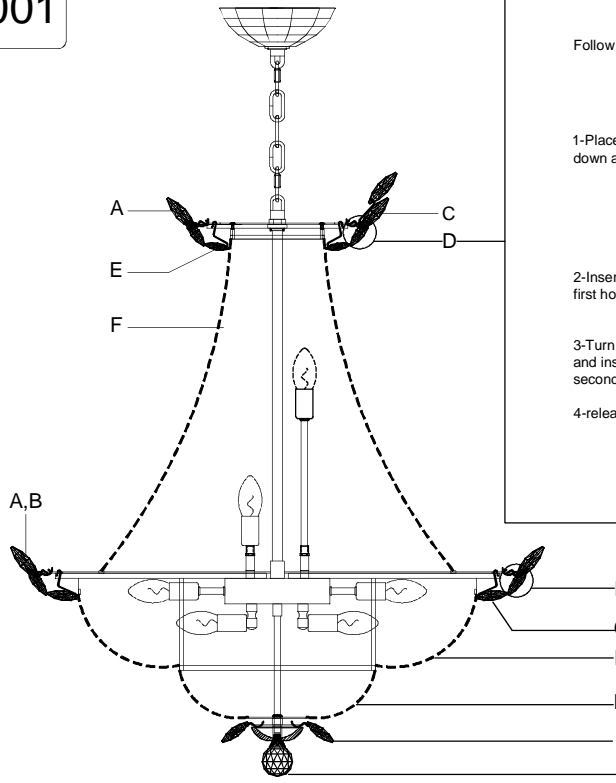

fig1. (D)
Follow these steps to install crystal D

1-Place crystal upside down as shown

2-Insert crystal pin on first hole

3-Turn crystal down and insert pin to second hole

4-release

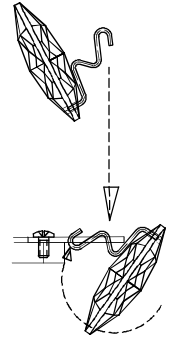

Middle Slotted ring top view

D-first hole
D-second hole

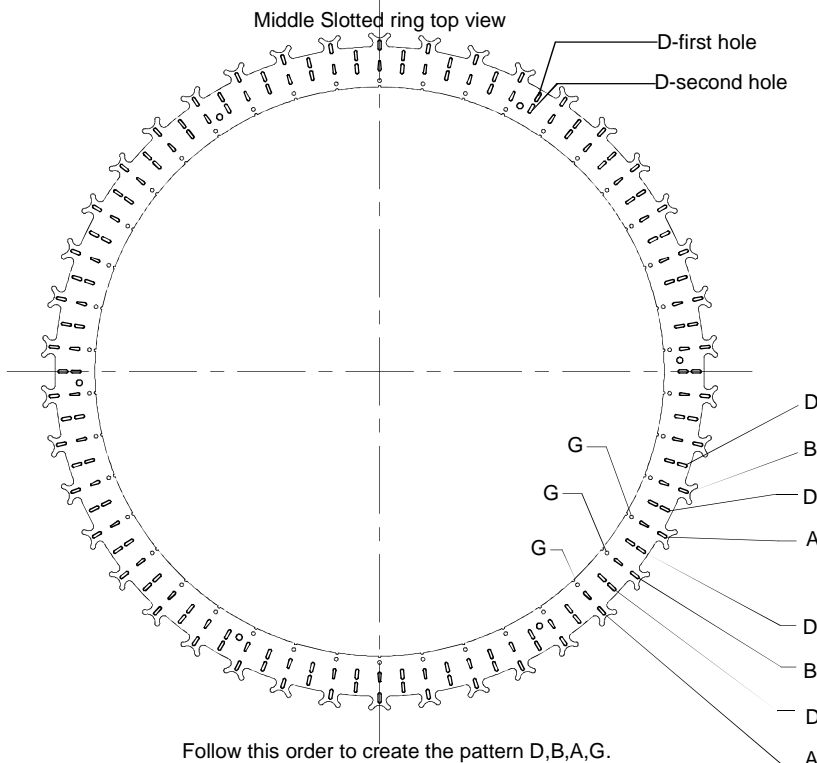

Follow this order to create the pattern D,B,A,G.

Top Slotted ring top view

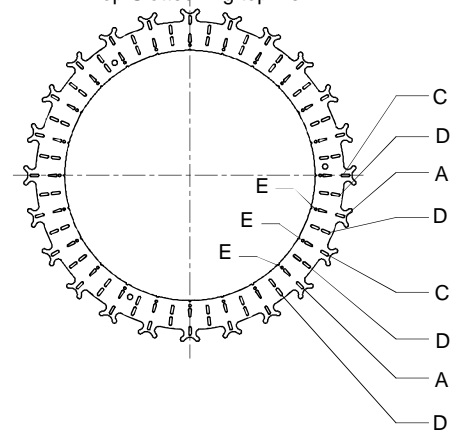

Follow this order to create the pattern D,C,A,E.

ALLEGRI

BY KALCO LIGHTING

CRYSTAL DRESSING INSTRUCTION

MODEL **020572-010-FR001**

WARNING

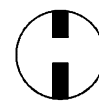

Electrical Danger Turn Power Off

All electrical components must be installed by a licensed electrician in accordance with the National Electric code and the appropriate local electrical codes.

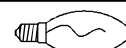

You will need 22 - Cand.Buld
40 Watts Recommended
40 Watts Max
Bulb not included

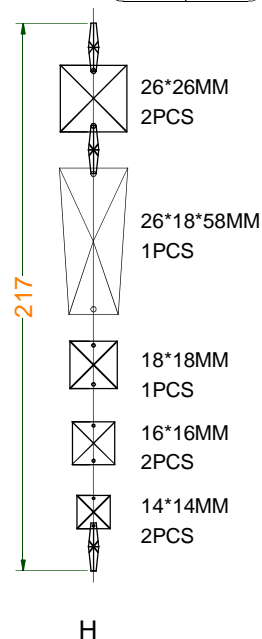
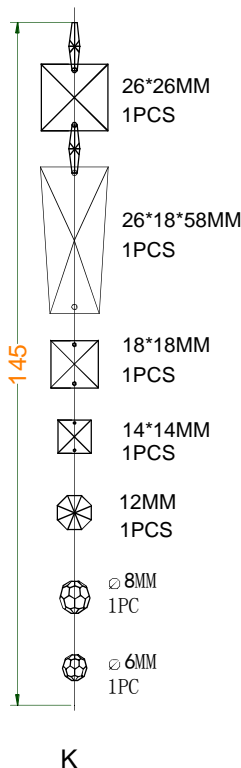
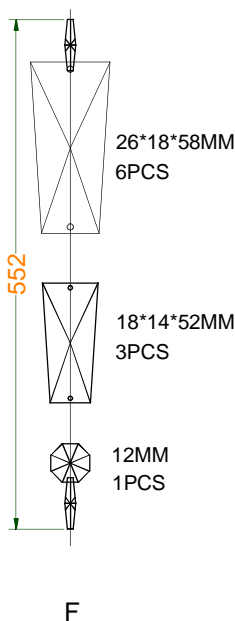
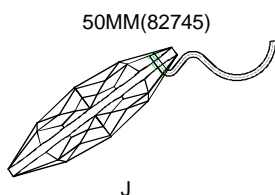
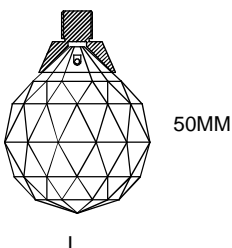
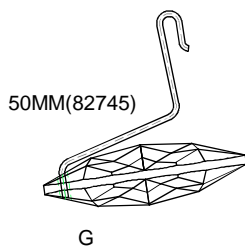
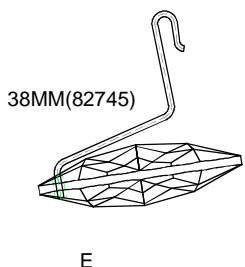
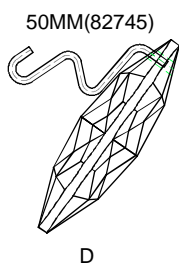
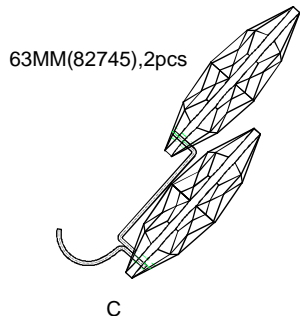
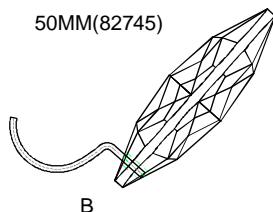
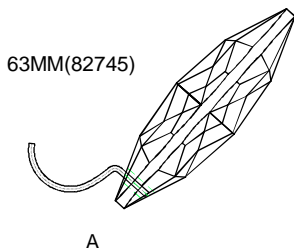

Code	Qty
A	48
B	36
C	12
D	96
E	24
F	36
G	72
H	72
I	1
J	10
K	36

ALLEGRI



BY KALCO LIGHTING

LIGHTING CARE INFORMATION

Every ALLEGRI® fixture is of heirloom quality and will last for generations. To ensure it retains its brilliance and splendor for years to come, proper care and regular cleaning are necessary.

It is recommended that ALLEGRI® fixture, and particularly their crystal trim, be lightly dusted with a feather or lambs wool duster, or soft brush every two months, or whenever it appears dull or dusty. A thorough cleaning should be completed every six months.

Before cleaning an ALLEGRI® fixture, first locate the fixture's trim diagram. This will assist in replacing the crystal trim in its proper location after cleaning. Should a replacement trim diagram be required, please call 866-820-2665 to speak with an ALLEGRI® customer service representative, who can provide a new diagram.

ALLEGRI® recommends several different cleaning methods, depending on the type of fixture. Some fixtures can be cleaned with limited removal of crystal, while others must be completely untrimmed.

Place a soft towel or blanket directly beneath the fixture to limit the damage to both the crystal and the surface below the fixture, should a piece of crystal be dislodged during the cleaning process. Extreme care must be taken around any electrical fixture. For personal safety and the safety of the fixture, be sure that the fixture has been turned off. Never rotate or spin the fixture as this can cause the fixture to lose support and fall. Instead, move around the fixture while cleaning.

White Glove Method

Prepare a cleaning solution of one part isopropyl alcohol to three parts distilled water and place in a clean spray bottle.

Do not use packaged cleaning fluids, as many of these contain ammonia, which may degrade the finish of the fixture and the quality of the crystal.

Wearing white cotton gloves, spray one glove with the solution and keep one dry. Gently polish each crystal with the damp glove and immediately wipe it with the dry glove. Do not tug or pull on the crystal, as this may cause the connectors to chip or crack the crystal, or dislodge it from the fixture.

Warning: To reduce the risk of personal injury due to fire and/or electric shock, never spray solution at or near the fixture.

Crystal Removal Method

Gently remove trim and hand-wash the crystal in lukewarm water using a mild detergent. Rinse in clean water and dry with a soft clean cloth. Do not soak finished crystal such as SWAROVSKI ELEMENTS Colors: Teak, Golden Shadow or Silver Shade, for extended periods, as this may degrade the crystal's finish.

With the fixture untrimmed and turned off, wipe the frame, including the light bulbs once they are completely cool, with a soft cloth.

Wearing white gloves, finger-cots or using a soft clean cloth, gently replace the trim as directed in the trim diagram.